

PLEASE NOTE: Check that you have received all components and hardware before assembling. If you are missing any parts, contact your retailer.

JEPPE Task Chair

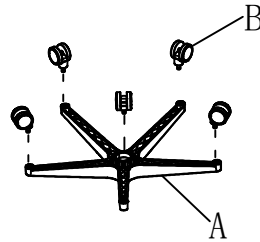

1



2

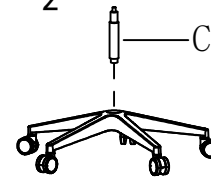

3

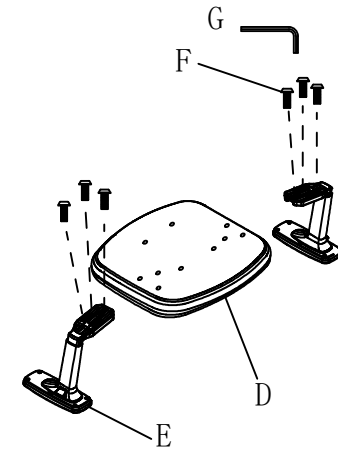

4

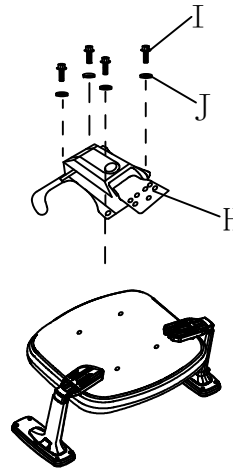

5

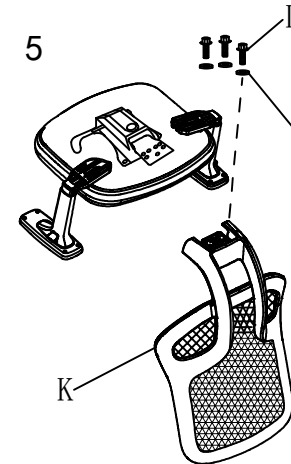

6

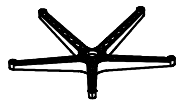
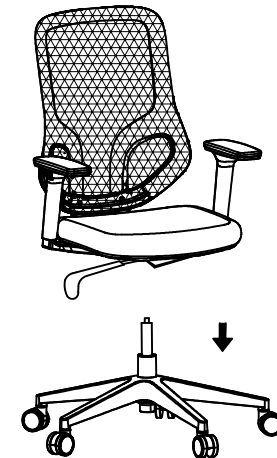

A (1 pc)



B (5 pcs)



C (1 pc)



D (1 pc)



E (2 pcs)



M6-1.25x40mm
F (6 pcs)

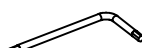

4mm
G (1 pc)



H (1 pc)



M6-1.25x35mm Ø8xØ17x2mm
I (4 pcs)



J (7 pcs)



K (1 pc)



M8-1.25x20mm
L (3 pcs)

During assembly, hand tighten screws only. When the screws are in place, tighten completely.

Function Description

PLEASE NOTE: Check that you have received all components and hardware before assembling. If you are missing any parts, contact your retailer.

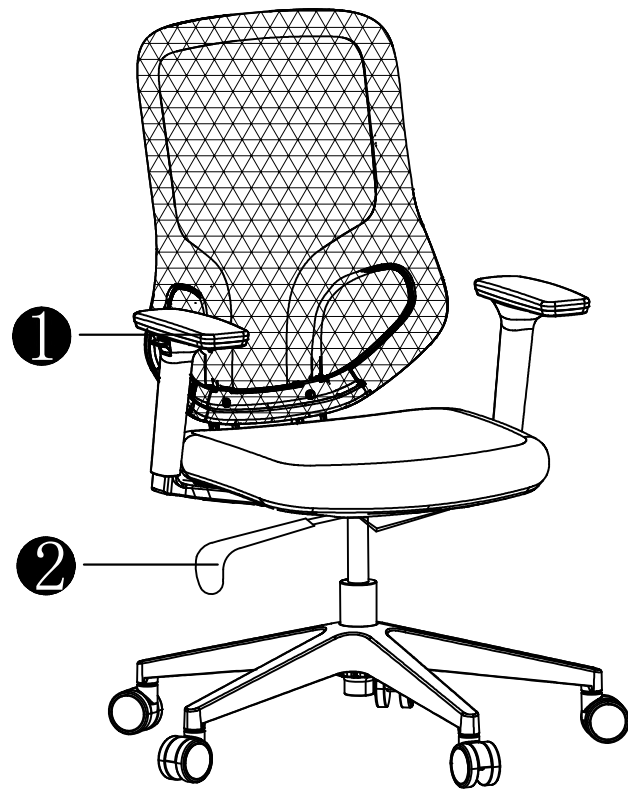

1 3D Arm adjustable

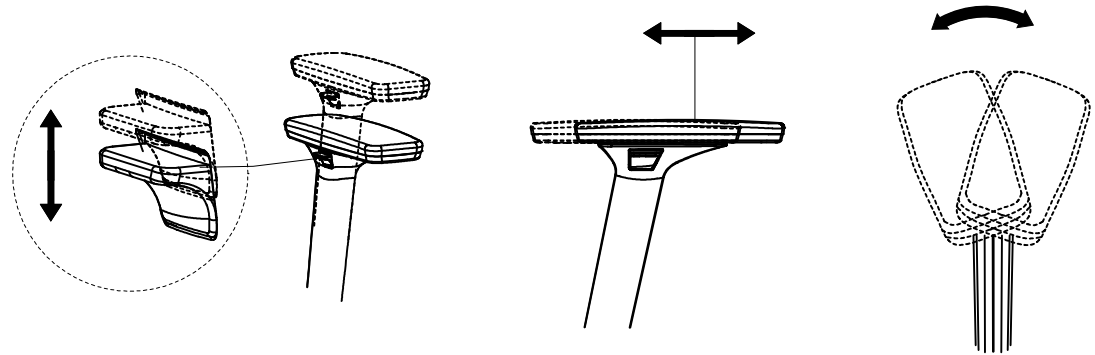

2 Chair tilt, lock and height adjustable

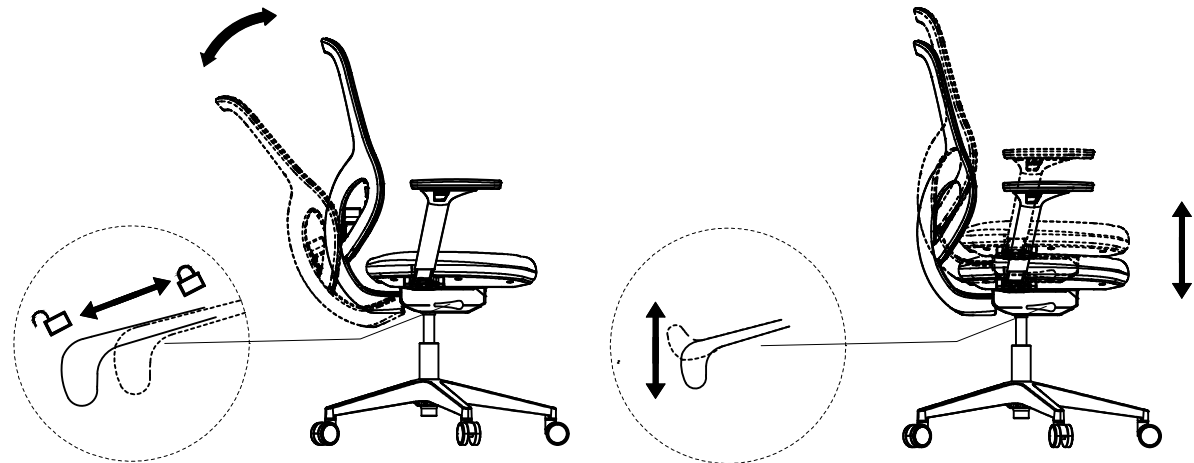

During assembly, hand tighten screws only. When the screws are in place, tighten completely.