

AMBER

Assembly Instructions

CHERRYMAN

A829 Storage Bookcase 4 Shelf

Ⓐ Ø15×33 15(PCS)

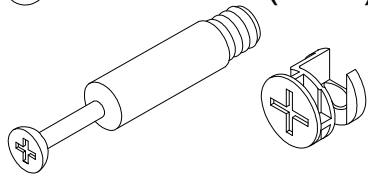

Ⓑ Ø8×30 20(PCS)

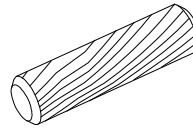

Ⓒ Ø22×27 4(PCS)

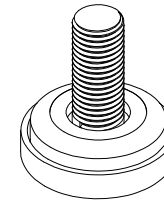

Ⓓ Ø5×18 20(PCS)

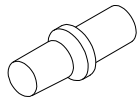

Ⓔ Ø3.5×16 8(PCS)

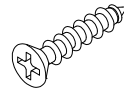

Ⓕ Ø15×1 15(PCS)

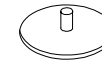

Ⓖ 25×25×20 2(PCS)

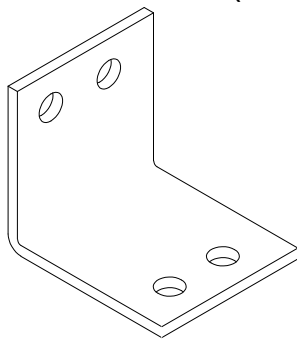

AMBER

Assembly Instructions

CHERRYMAN

A829 Storage Bookcase 4 Shelf

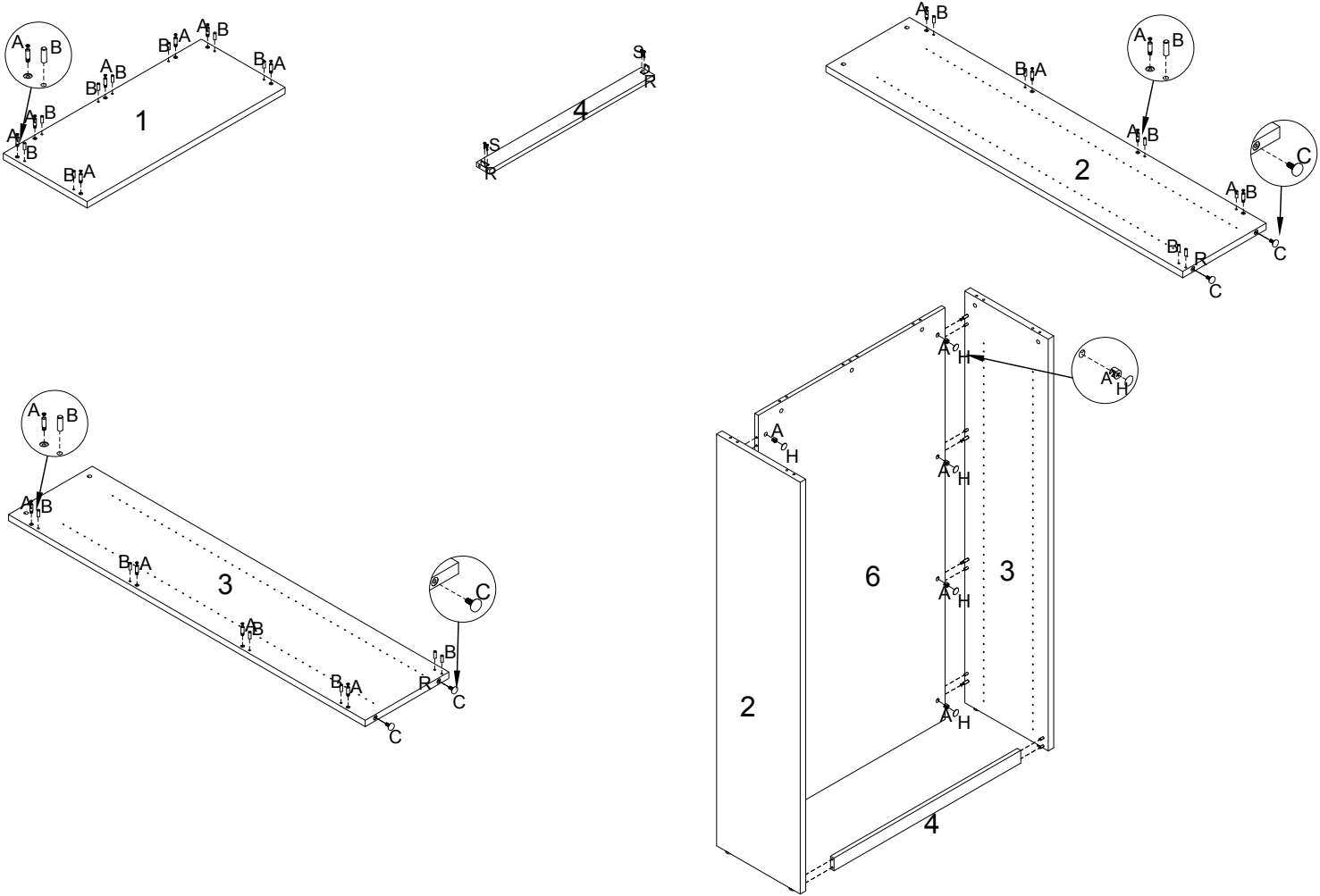

AMBER

Assembly Instructions

CHERRYMAN

A829 Storage Bookcase 4 Shelf

