

# AMBER

## Assembly Instructions

CHERRYMAN

A827 Storage Lateral 2 File

Ⓒ  $\phi 22 \times 27$  4(PCS)

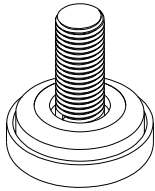

Ⓔ 2(PCS)

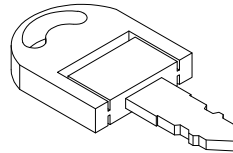

Ⓓ 96MM 2(PCS)

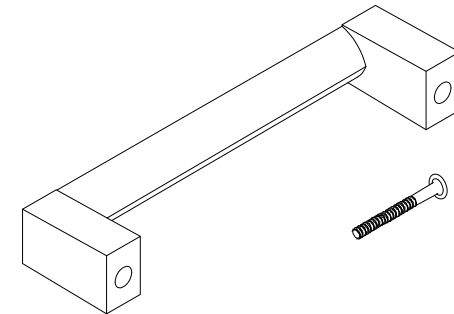

Ⓖ  $\phi 3.5 \times 16$  8(PCS)

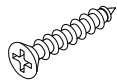

Ⓦ  $\phi 4 \times 30$  2(PCS)

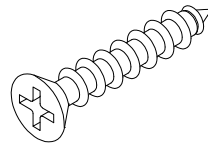

Ⓐ2 377MM 4(PCS)

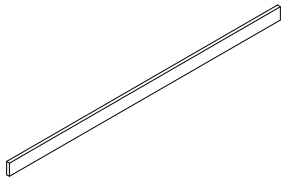

Ⓐ3 809MM 2(PCS)

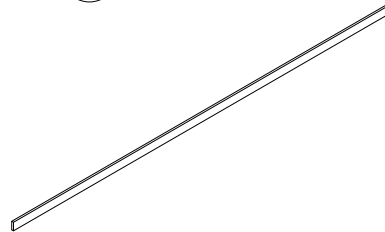

Ⓩ 8(PCS)

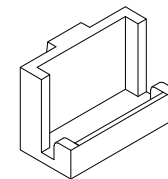

# AMBER

## Assembly Instructions

CHERRYMAN

A827 Storage Lateral 2 File

