

# AMBER

## Assembly Instructions

CHERRYMAN

A540 Storage Cabinet 2 Door

A  $\phi 15 \times 33$  16(PCS)

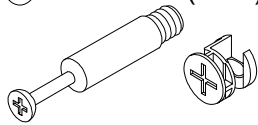

B  $\phi 8 \times 30$  20(PCS)

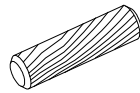

C  $\phi 22 \times 27$  4(PCS)

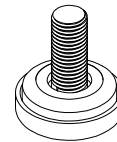

D  $\phi 50$  2(PCS)

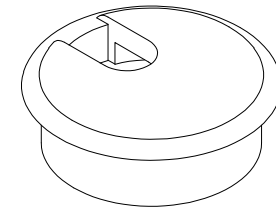

G  $\phi 3.5 \times 16$  24(PCS)



H  $\phi 15 \times 1$  16(PCS)



M DTC 4(PCS)

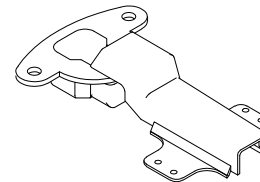

Q  $\phi 5 \times 18$  4(PCS)



O  $\phi 15 \times 2$  4(PCS)



R  $25 \times 25 \times 20$  2(PCS)

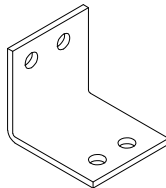

S  $\phi 3.5 \times 16$  8(PCS)



T 96MM 2(PCS)

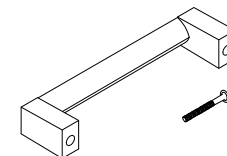

# AMBER

## Assembly Instructions

CHERRYMAN

A540 Storage Cabinet 2 Door

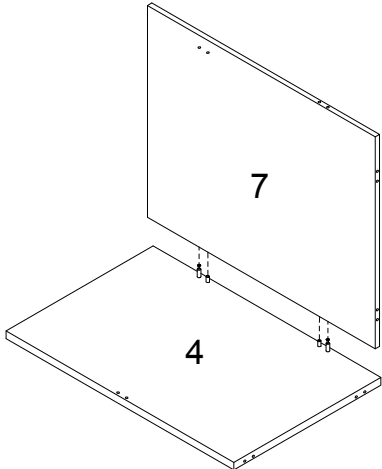
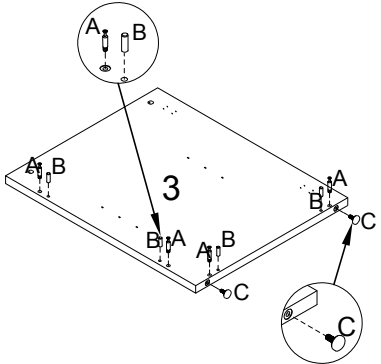
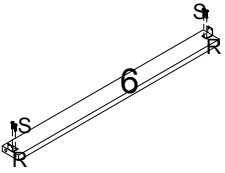
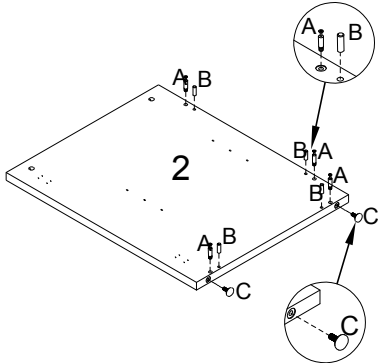
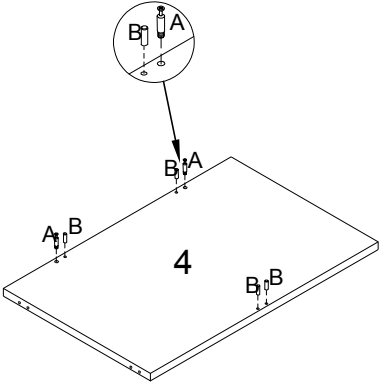
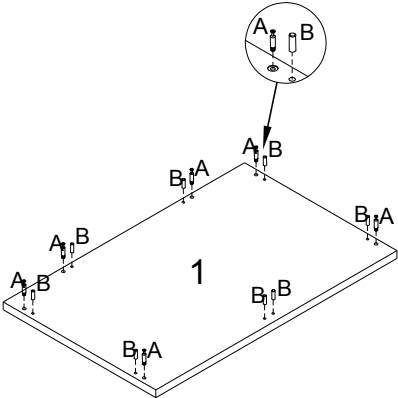

# AMBER

## Assembly Instructions

CHERRYMAN

A540 Storage Cabinet 2 Door

